

# Automatic Generation Control of Three Area Power Systems Using Ann Controllers

Nehal Patel<sup>1</sup>, Prof. Bharat Bhusan Jain<sup>2</sup>  
<sup>1&2</sup> Arya College of Engineering & Technology, Jaipur, Rajasthan

## ABSTRACT

This paper presents the use of one of the methods of artificial intelligence to study the automatic generation control of interconnected power systems. In the given paper, a control line of track is established for interconnected three area thermal-thermal-thermal power system using generation rate constraints (GRC) & Artificial Neural Network (ANN). The proposed control has been designed for a three-area interconnected power system that two areas include steam turbines, artificial neural network (ANN) controller, which controls the inputs of each area in the power system together, is considered. The working of the controllers is simulated using MATLAB/SIMULINK package. The outputs using both controllers are compared and it is established that ANN based approach is better than GRC for 1% step load conditions. The performance of the power system is simulated by using GRC and ANN controller, separately. By comparing the results for both cases, the performance of ANN controller is better than GRC.

**KEYWORDS:** Load Frequency Control(LFC), Automatic Generation Control(AGC), ANN Controller, Area Control error(ACE), Narma controller, Tie-line, Control System Tool, MATLAB / SIMULINK.

## I. INTRODUCTION

One of the important issues in the operation of power system is Automatic Generation Control (AGC). It helps in supplying adequate and consistent electric power with good quality. It is the secondary control in LFC which re-establishes the frequency to its nominal value (50 Hz) and sustains the interchange of power between areas (in case of more than one control area). For this the load demand in the generator prime mover set is increased or decreased in the form of kinetic energy, resulting in change of frequency. The primary and tertiary control is performed by speed governors and economic dispatch respectively. The transient in primary, secondary and tertiary control is of the order of seconds and minutes respectively. Automatic generation control (AGC) is defined as the regulation of power output of controllable generators within a prescribed area in response to change in system frequency, tie-line loading or a relation of these to each other, so as to maintain the scheduled system frequency and / or to establish the interchange with other areas within predetermined limits [2]. Thus, a plan is required to maintain the frequency and desired tie line power flow as well to accomplish zero steady state error. Different types of. The most common of the controllers employed for AGC is Integral controller which is very simple to implement and gives better performance. But its performance goes down as the system becomes more and more complex. Therefore Artificial Intelligent controllers like Neural control approach is more suitable in this respect as It has advance adaptive control configuration [3]. In this paper, the performance evaluation Artificial Neural controller for three areas interconnected thermal-thermal-thermal power plant is proposed.

The beginning of artificial intelligence (AI) techniques persisting of neural networks has elucidated many problems. This technology mainly helps in those kinds of systems which are operating nonlinearly over the operating range. ANN has also been used in frequency controller design for Multi area AGC scheme in deregulated electricity market [4], [5]. These networks have been used for pattern recognition, function approximation, time series prediction and classification problems for quite some time. Even, ANNs have been successfully applied to the AGC problem with rather promising results [6], [7], [15]. In this paper, a three area interconnected power system [1] is selected and Load Frequency Control (LFC) of this system is done using an ANN controller [7], [8], [15]. Each area needs its system frequency to be controlled [9], [10], [11]. Artificial Neural Network (ANN) controller has advanced adaptive control configuration, faster control [3] and continues to function without needing any decision support software in case of a failure. The performance of ANN controller is compared with conventional Integral controller.

## II. MODELING INCLUDING GRC

In power system having steam plants [16], power generation can change only at a specified maximum rate. The generation rate (from safety consideration of the equipment) for the units is quite low. If these constraints are not considered, system is likely to chase large momentary disturbances. This results in undue wear and tear of the controller. When GRC is considered the system dynamic model becomes non-linear and linear control techniques cannot be applied for the optimization of the controller settings. If the generated rates are included in the state vector, the system order will be altered. Instead of augmenting them, while solving the state equations, it may be verified at each step if the GRCs are violated. Another way of considering the GRCs for all the areas is to add limiters to governors as shown in figure below, i.e. the maximum rate of valve opening or closing is restricted by limiters.

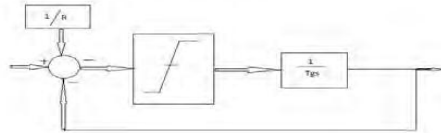

Fig 1: Governor model with GRC

The GRC result in larger deviations in ACEs as the rate at which generation can change in the area is constrained by limits imposed. Therefore the duration for which power needs to be imported increases considerably.

## III. ARTIFICIAL NEURAL NETWORK

The foundation of Artificial neural networks(ANN) are the simple models for neurons and their links can be successful for learning and decision making if the model is pattern based (the Perceptron model) and/or is memory storing and recall process (the Hopfield network). They have numerous applications even outside of neuroscience. Some basic features of neural networks are:

- i) Noisy data can be used in the problem.
- ii) The network can 'trained' on set of sample solutions for producing good performance.

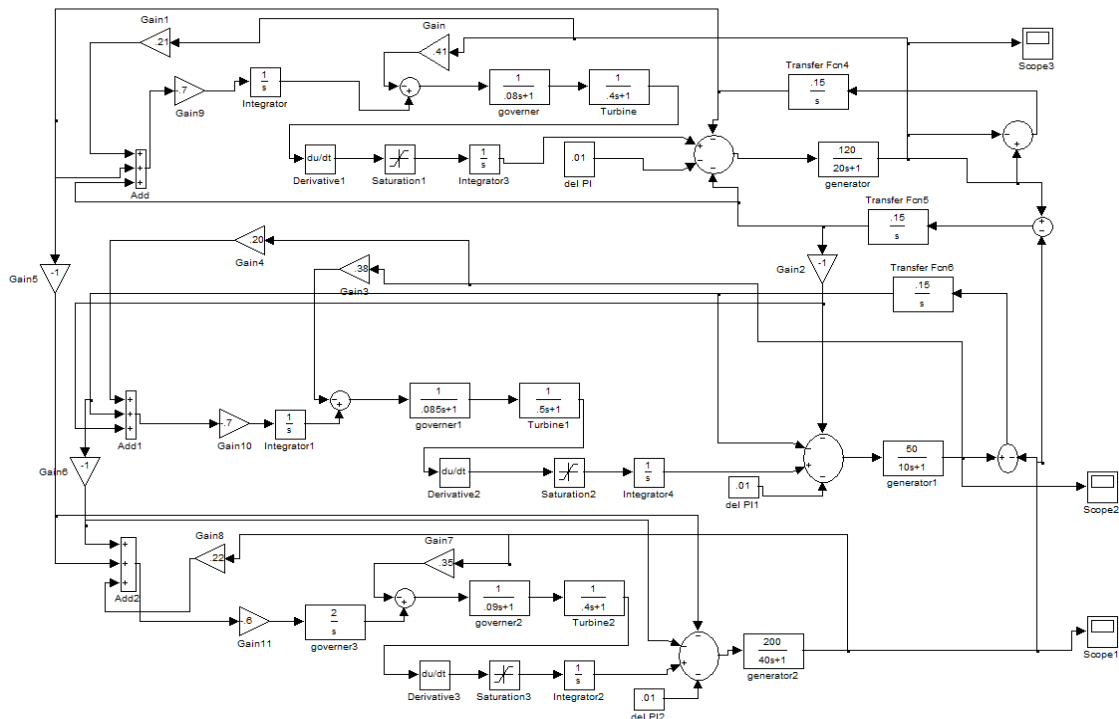

Fig 2: Simulink model of three area interconnected power system with non reheat turbine using GRC

ANN is a system having elements called as neurons which processes the information and this information is transmitted by means of connecting links associated with weights, which is multiplied to the incoming signal (net input) for any typical neural net, and the output signal is obtained by applying activations to the net input. The block diagram of system added ANN architecture is shown in fig. 3

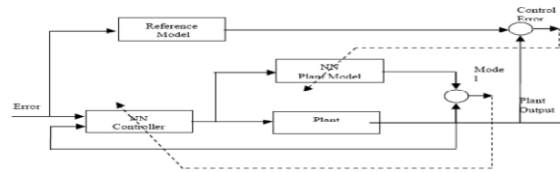

Fig.3 System added ANN architecture

### 3.1.Narma-L2 Control

ANN controller architecture employed here is Non-linear Auto Regressive Model reference Adaptive Controller[13]. Computations required for this controller is quite less. It is simply a rearrangement of the neural network plant model, which is trained offline, in batch form. It consists of reference, plant output and control signal. The plant output is forced to track the reference model output. Here, the effect of controller changes on plant output is predicted. It permits the updating of controller parameters. In the study, the frequency deviations, tie-line power deviation and load perturbation of the area are chosen as the neural network controller inputs. Control signals applied to the governors in the area act as the outputs of the neural network. The data required for the ANN controller training is obtained by designing the Reference Model Neural Network and applying to the power system with step response load disturbance. ANN controller used is a three-layer perceptron with one input, 15 neurons in the hidden layer, and one output. ANN Plant model is a three-layer perceptron with one input, 15 neurons in the hidden layer, and one output. The activation function of the networks neurons is train-lm function. 100 training samples have been taken to train 10 number of epochs. The proposed network has been trained by using the learning performance. Learning algorithms causes the adjustment of the weights so that the controlled system gives the desired response. (Fig. 4).

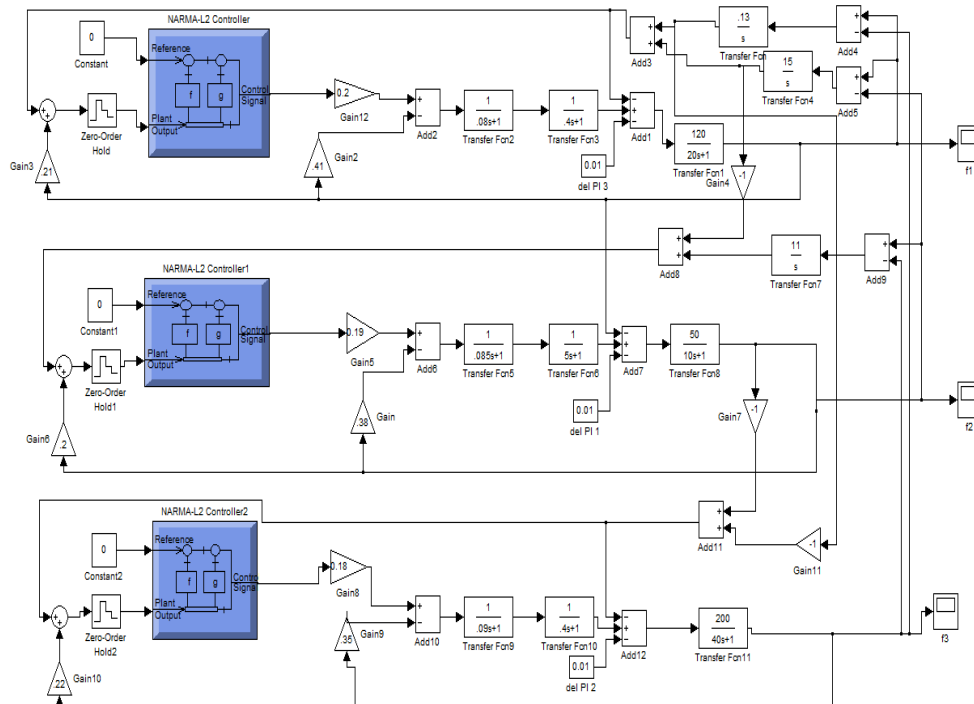

Fig 4: Simulink model of three area interconnected thermal with NARMA Controller

## IV. SIMULATION AND RESULT

In the present work, a thermal-thermal-thermal interconnected power system has been developed using ANN controllers and integral controllers to demonstrate the performance of load frequency control using MATLAB/SIMULINK package. Fig. 5, 6, 7 respectively represent the plots of change in system frequency and tie-line power respectively for 1% step load variation.

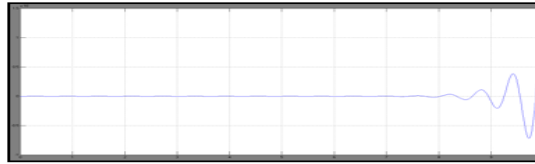

Fig 5: Waveform of f1 with Auto scale using NARMA controller

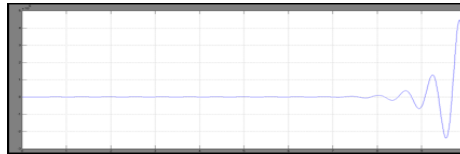

Fig 6: Waveform of f2 with Auto scale using NARMA controller1

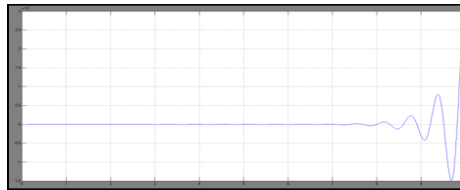

Fig 7: Waveform of f3 with Auto scale using NARMA controller2

#### 4.1 Plant Identification Of Window

Then Import Data from Array & Structure with sampling interval (0.02 sec) with input array (simout1) & output array (simout2) with 100 training samples.

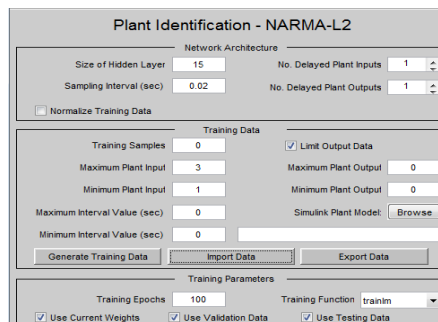

Fig 8: Plant Identification of controller

#### 4.2 Import Data Window

Here simout1 act as a input array and simout2 act as a output array. Then import data from array and structure with sampling interval (0.02 sec) with input array (simout1) and output array (simout2) with 100 training. These terms import from workspace.

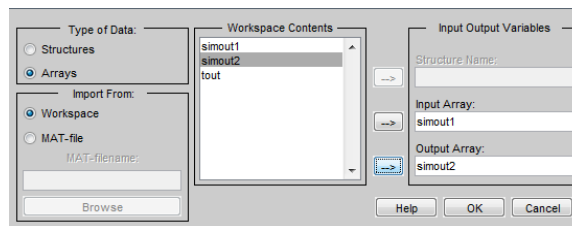

Fig 9: Import Data controller

#### 4.3 Plant Input-Output Data Of Window

This data shows that plant input and plant output puts very small variation.

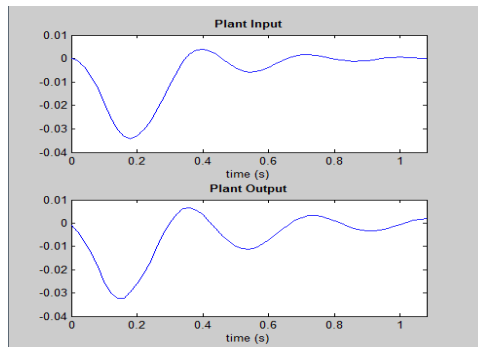

Fig 10: Plant Input-output Data controller

Now after accept data Train network then Apply & Ok

#### 4.4 Neural Network Trained Tool Window

According to this parameter all the contents are visible and it also shows Performance, Training state and Regression. Here epochs of this parameter showing 1 epochs during plot interval

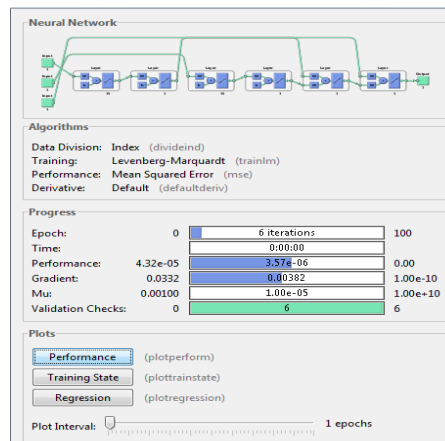

Fig 11: Neural Network trained Tool controller

#### 4.5 Performance Window

This data showing training, validation and testing data through workspace. It shown the best validation performance through the epoch's period.

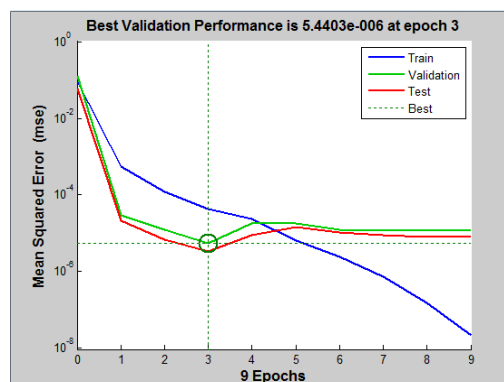

Fig 12: Performance controller

#### 4.6 Training State Window

The Training state of any workspace shows the different no. of epochs in any power system.

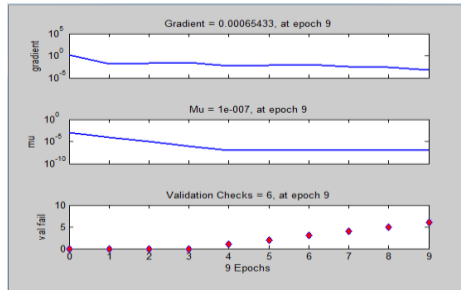

Fig 13: Training State controller

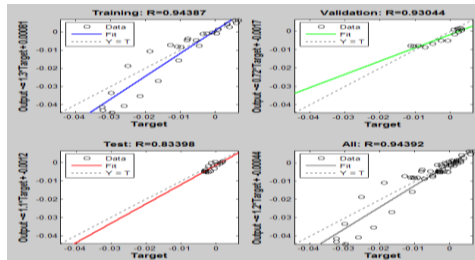

Fig 14: Regression controller

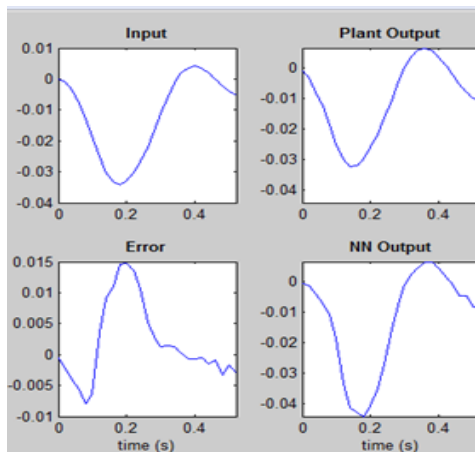

Fig 15: Training data

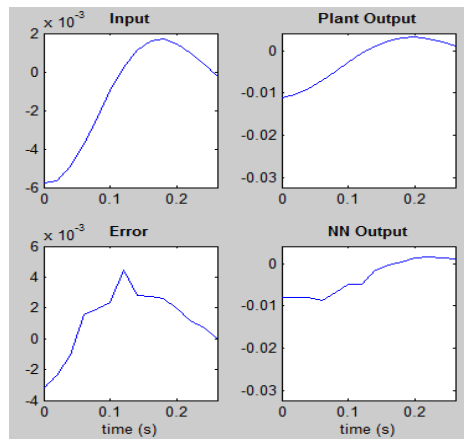

Fig 16: Validation Data

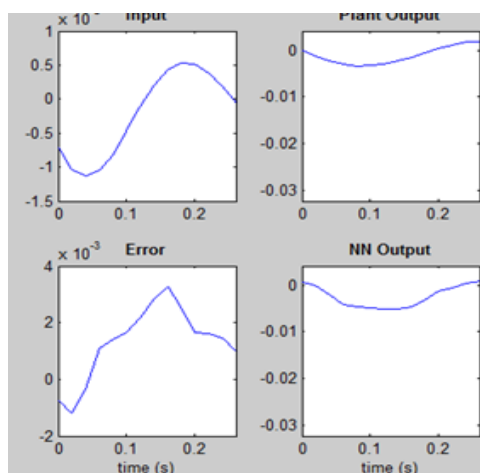

Fig 17: Testing Data

## V. CONCLUSIONS

From the responses obtained, it is clear that use of ANN controller improves dynamic performance and reduces the overshoots w.r.t frequency deviation in each of the areas. Therefore, the intelligent control approach using ANN concept is more accurate and faster. And also it gives better results even when GRC are considered.

## REFERENCES

- [1] J.Nanda & A. Mangla," Automatic Generation Control of an Interconnected Hydro-Thermal System using conventional Integral & Fuzzy Logic Controller." IEEE International Conference on Electric Utility Deregulation Reconstructing & Power Technology, April 2004
- [2] Elgerd O. I. 1971. Electric Energy System Theory; An Introduction, Mc Graw Hill
- [3] Demiroren A., Zeynelgil H.L., Sengor N. S. "The Application of ANN Technique to Load-frequency Control for Three- area Power System", *IEEE Porto Power Tech Conference*, PPT001, Porto, Portugal, 10<sup>th</sup> -13th September 2001.
- [4] Sandeep Bhongade, Prof.H.O.Gupta, "Artificial Neural Network based Automatic Generation Control scheme for Deregulated Electricity Market", IPEC, 2010 Conference proceedings, pp.1158-1163, 2010
- [5] Bibhu Prasad Padhy, Barjeev Tyagi, "Artificial based Multi Area Automatic Generation Control scheme for a Competitive Electricity Market Environment", International Conference on Power systems, ICPS 09, pp.1-6, 2009.
- [6] M.Ansarian, Shakouri, "A Novel Neural Optimal Approach for Decentralized Load Frequency Control design in Multi Area Power System", Power and Energy Conference 172, 2006
- [7] J .A. Jaleel, T.P.I.Ahammed, "Simulation of ANN Controller for Automatic Generation Control of Hydroelectric Power System", pp.1- 4, TENCON-2008, 2008
- [8] I.A..Chidambaram, R.Francis, "Automatic Generation Control of a Two Area Reheat Interconnected System based on CPS using Fuzzy Neural Network", Emerging Trends in Electrical and Computer Technology (ICETECT), pp.200-205, 2011
- [9] C.S. Chang, Weihui fu, Area Load Frequency Control using Fuzzy Gain scheduling of PI controllers, systems research, pp.145-52, vol.42, 1997.
- [10] K. P. Singh Parmar, S. Majhi and D. P. Kothari, Generation Control of an Interconnected Hydrothermal Power System, IEEE Conf. proceedings, Kolkata, India, INDICON 2010.
- [11] K. P. Singh Parmar, S. Majhi and D. P. Kothari, Load Frequency Control in a Power System Using Optimal Output Feedback Method , New Delhi, India , IEEE Conf. proceedings 2010.
- [12] J.Nanda S.Mishra "A novel classical controller for automatic generation control in thermal and hydrothermal systems" Power Electronics, Drives and Energy systems (PEDES) pp. 1-6, 2010.
- [13] Surya Prakash , S. K. Sinha "Application of artificial intelligence in load frequency control of interconnected power system" INTERNATIONAL JOURNAL OF ENGINEERING, SCIENCE AND TECHNOLOGY, pp. 264-275, Vol. 3, No. 4, 2011.
- [14] Hadi Sadat, "Powet System Analysis", TMH, 2002.
- [15] Murat LÜY, İlhan KOCAARSLAN, Ertuğrul ÇAM, M. Cengiz TAPLAMACIOĞLU, "LOAD FREQUENCY CONTROL IN A SINGLE AREA POWER SYSTEM BY ARTIFICIAL NEURAL NETWORK (ANN)".
- [16] D.P.Kothari, I.J. Nagrath, "Power System Engineering", Tata McGraw Hill, second edition.